

Contest Description

COMPETITION DATE: Friday, March 24	CONTEST AREA NAME: Mobile Robotics
CONTEST AREA NUMBER:	LEVEL: Secondary
DURATION OF CONTEST: 6 hours	LOCATION: CNA Prince Philip Drive Campus

PROVINCIAL TECHNICAL COMMITTEE MEMBERS

NAME	EMAIL ADDRESS
Dave Keefe -NTC & Provincial Chair	davidkeefe01@gmail.com
Steve Noseworthy	
Colby Prior	
Jordan Smith	

Robot Hockey Game

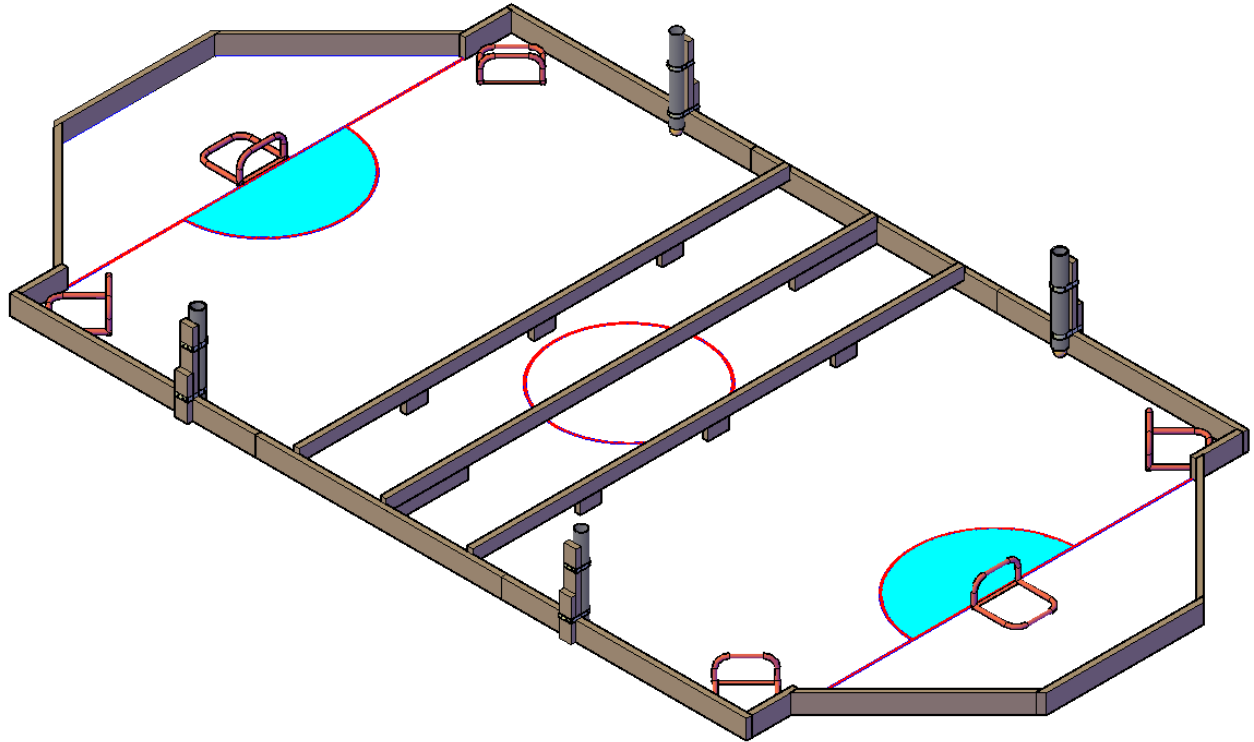

Figure 1: Overall Court

Date: March 2023

CNA, Prince Philip Drive Campus, St. John's, NL

FURTHER COMMUNICATIONS

QUESTIONS FOR CLARIFICATION OF THE RULES CAN BE MADE TO YOUR PROVINCIAL TECHNICAL COMMITTEE.

Table of Contents

Figure 1: Overall Court	0
1. Definition of terms referenced in this document	4
2. The Robot Hockey Game Teleoperation Game Overview	4
3. Detailed Court Areas	5
3.1: Neutral Zone	5
<i>Figure 2: Neutral Zone</i>	6
3.2: Defensive Zone	6
<i>Figure 3: Defensive Zone</i>	7
3.3: Shooting pathways	7
<i>Figure 4: Shooting pathways</i>	8
3.4: Ball Dispenser	8
<i>Figure 5: Ball dispenser</i>	9
3.5: Goal Areas	9
<i>Figure 6: Net placement</i>	10
3.6: Driver Zones	10
<i>Figure 7: Driving zones</i>	11
3.7: Starting Zone	11
<i>Figure 8: Starting zones</i>	12
3.8: Game Pieces	12
<i>Figure 9: Standard Net with Corrugated Plastic</i>	13
3.9: Shooting Mechanisms	13
<i>Figure 10: Curve Length Measuring Points</i>	14
3.10: Additional Notes	15
4. Each Team's Exclusive Use Area is approximately 12 ft. by 12 ft.	15
5. Each Team's Area includes:	16
5.1: Starting Area	16
<i>Figure 11: Starting areas</i>	17
5.2: Tele-op Area	17

<i>Figure 12: Tele-op area</i>	18
5.3: Autonomous Area	18
<i>Figure 13: Autonomous area</i>	18
6. Hockey Game Description	18
7. Scoring Summary	18
7.1: Opponent Zone Balls	19
7.2: Neutral Zone Balls	19
7.3: Tie-breaker	19
7.4: Match Record and Point Standings	19
8. Marking Sheet	20
9. Pit Area and Court Access	21
10. Game Play	21
11. Court Layout	23
12. The Robot(s) Restrictions	23
13. Start of the Game Robot Status	23
14. Overall Team Robot Entry Size	24
15. Power Sources / Management	24
Figure 14: Circuit Protection	25
16. Non-Electrical (Battery) Energy Sources	26
17. Recommended Robot Controllers	26
18. Pit Area	26
19. Overall Court Description:	27
20. Pre-inspection for Compliance with Safety and Design Rules	28
21. Autonomous Competition Overview:	29
21.1 Exception List to “Only what is in the box”	30
<i>Appendix A: Court Area Dimensions and Details</i>	31

1. Definition of terms referenced in this document

- a. Tele-Operated Robot Elements are elements under the direct/active control of competitors during game play using one or two radios/game controllers held by the courtside competitors.
- b. Mobile Independent Autonomous Mobile Robot Elements are elements that at the start of a game have a competitor pressing their start button or enter on a computer keyboard as the only “Competitor” to “Independent Autonomous Mobile Robot Element” communication during the entire game.
- c. Stationary Independent Autonomous Elements are elements that have their power on at the start of games but have no direct contact with a competitor during game play. These units may interact with the team’s tele-operated mobile robot with the actions of the tele-operated mobile robot triggering an active response by the Independent Autonomous Element which may be managed either by a mechanical based system (eg. A series of limit switches / no programmed elements) or a pre- programmed system (eg. Managed by an Arduino or other microprocessor) internal to the Independent Autonomous Element.

2. The Robot Hockey Game Teleoperation Game Overview

- a. The core game situation requires a Robot or Robots to use the components provided in their Exclusive Use Court Space to (a) retrieve the hockey balls from their dispenser and (b) “shoot” the ball into the other team’s net, while also trying to prevent the other team from “shooting” the ball into your own net.
- b. The goal of this game is to shoot the balls into your opponent’s nets!

3. Detailed Court Areas

3.1: Neutral Zone

- a) The center court area consists of 2 sections, divided in the middle of the overall court.
 - a. These areas are 24 inches (2 feet) in width, and 144 inches (12 feet) in length.
 - b. These areas are separated by a barrier wall, which is composed of two 2x4s on top of each other, with the bottom one having an 8 ft long gap in the middle.
- b) These areas are separated from the team's defensive zone by a barrier wall, which is composed of two 2x4s on top of each other, with the bottom one having four 31.5 inch gaps evenly distributed along the length of the barrier.
- c) Each team will have one section of the Neutral Zone, which is on their half of the court.
 - a. Teams may have a single Autonomous robot operating in their Neutral zone.
 - b. No tele-operated robots are permitted in the Neutral Zone.

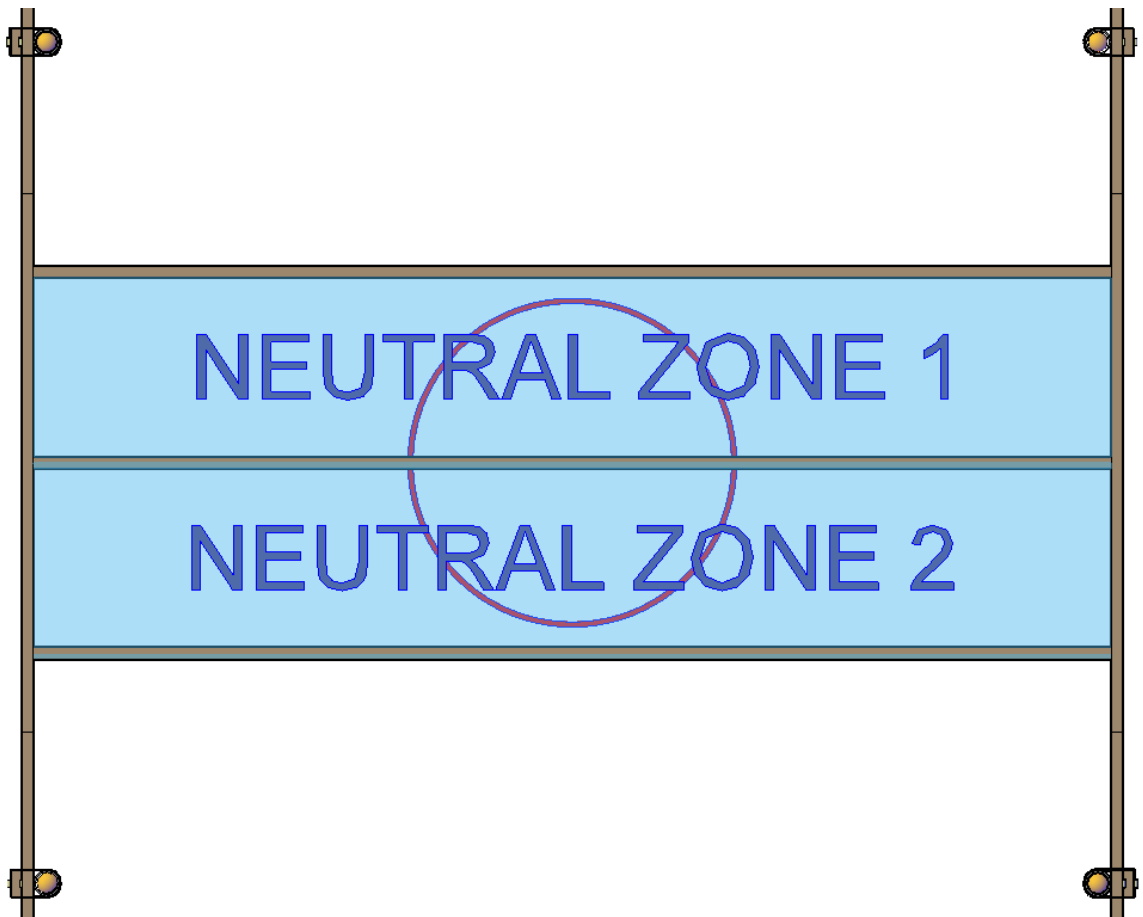

Figure 2: Neutral Zone

3.2: Defensive Zone

- a) The end areas of the overall court are defined as the “Defensive Zone”.
- b) The Defensive Zone ranges from the Neutral zone barrier to the end of the court.
 - a. The defensive zone consists of a rectangular area (between the goal line and the blue line) and a trapezoidal area (behind the goal line).
 - b. The defensive zone rectangular area measures 144 x 80.25 inches.
 - c. The defensive zone trapezoidal area measures 36 inches (goal line to back wall), with the goal line side being 120 inches and the back wall side being 48 inches.
- c) Contained within each Defensive Zone:
 - a. 3 nets
 - b. 2 ball dispensers
- d) Each team can operate up to 2 Tele-operated robots in their defensive zone.
 - a. Teams have exclusive use of their defensive area.
 - b. Teams are not allowed to move any of the set game pieces (the nets).
- e) The goal is to shoot balls from your own defensive zone into your opponent’s zone (and nets).

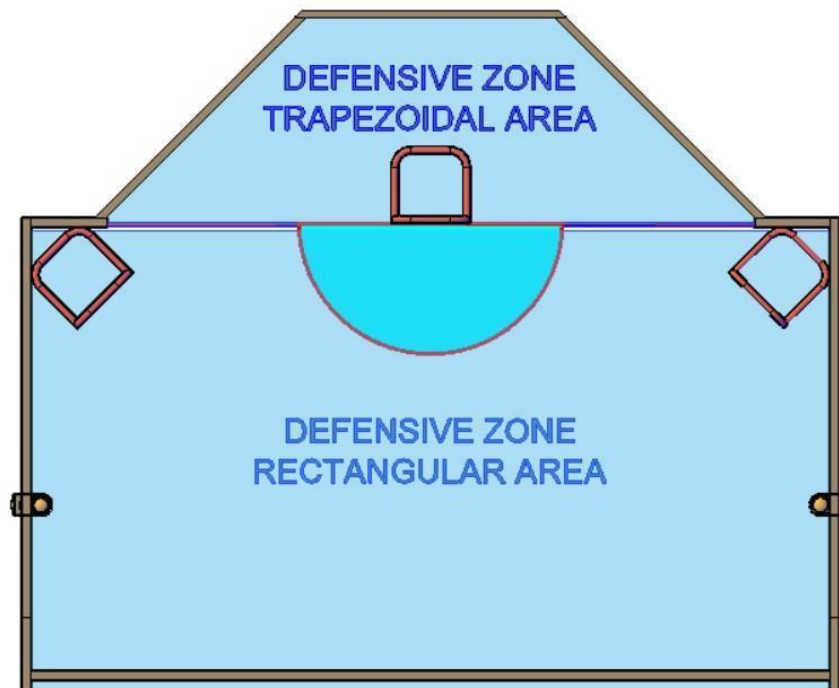

Figure 3: Defensive Zone

3.3: Shooting pathways

- a) When a team shoots the ball, it must be shot from their own zone.
 - a. Tele-op robots must shoot from their defensive zone.
 - b. Autonomous robots are allowed to shoot from their respective neutral zone.
- b) The shot must go through the shooting pathways
 - a. These shooting pathways are cut out sections of the barriers between zones.
 - b. These cut out sections are on the court floor.
 - c. The balls must not go over the barriers.
- c) There is one shooting pathway through the “Center line” barrier.
 - a. It is 8 feet wide and centered along the “Center line”.
- d) There are 4 shooting pathways through the “Blue line” barriers.
 - a. Each opening is 31.5 inches wide.
 - b. There is a 6 inch space between the open pathways.

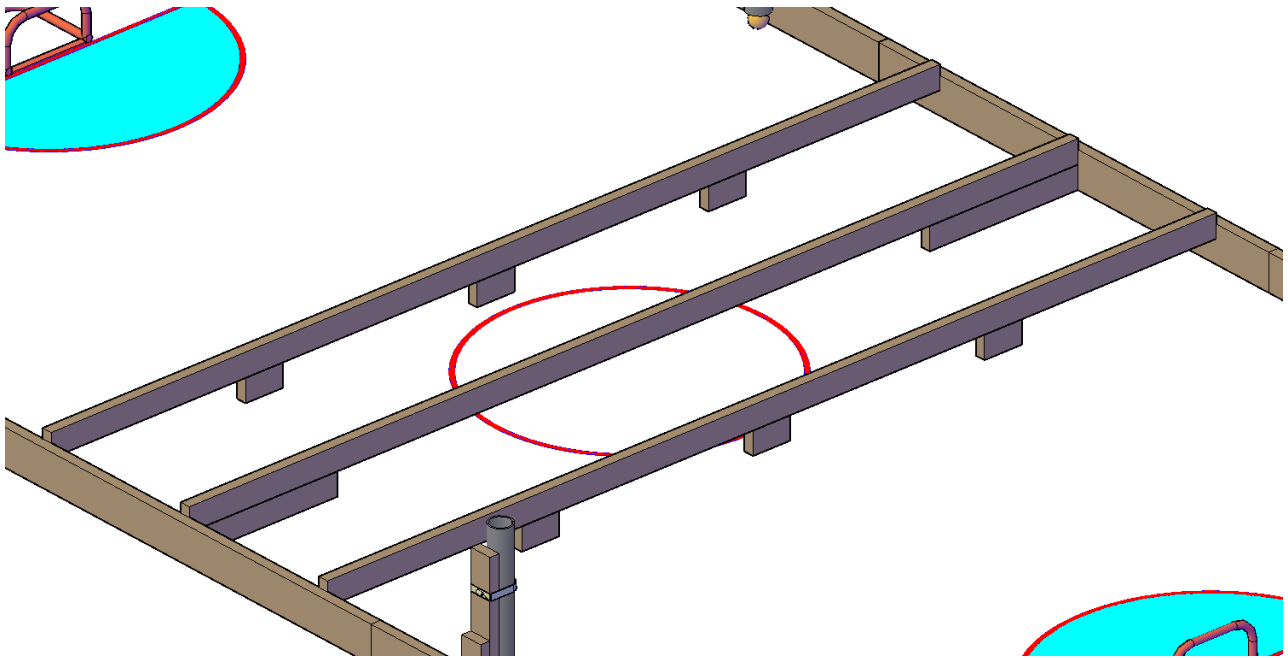

Figure 4: Shooting pathways

3.4: Ball Dispenser

- a) Located along the side exterior walls are 2 ball dispensers.
- b) They are located 30 inches from the edge of the “Neutral Zone” barrier to the center of the “Ball Dispenser” in the “Rectangular Defensive Zone” along the exterior walls (one dispenser on each side of the court).
- c) Ball dispensers are constructed of 3 inch (inner diameter) pipe.
 - a. The pipe is held 2.5 inches off the court floor surface.
 - b. The pipe will be held in place vertically, at 90 degrees to the court floor.
 - c. The pipe will be secured to a standing 2x4 with pipe clamps, as depicted in the court construction information (see appendix).

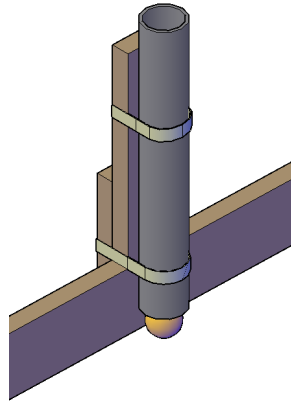

Figure 5: Ball dispenser

3.5: Goal Areas

- a) Each Defensive Zone will have 3 miniature hockey nets.
- b) The nets are “Franklin Sports Mini Skills Street Hockey Goal - Outdoor + Indoor Steel Mini Hockey Net” available [here](#), or a hand-made equivalent with identical dimensions.



- c) Each net is located in a set place, not to be moved by any robot operation.
 - a. One net is placed along the goal line, with its goal line lining up with the court's goal line, in the middle of the court (width wise).
 - b. The other 2 nets are placed in each corner area, at a 45 degree angle, directly against the walls.
 - c. Refer to diagram for placement:

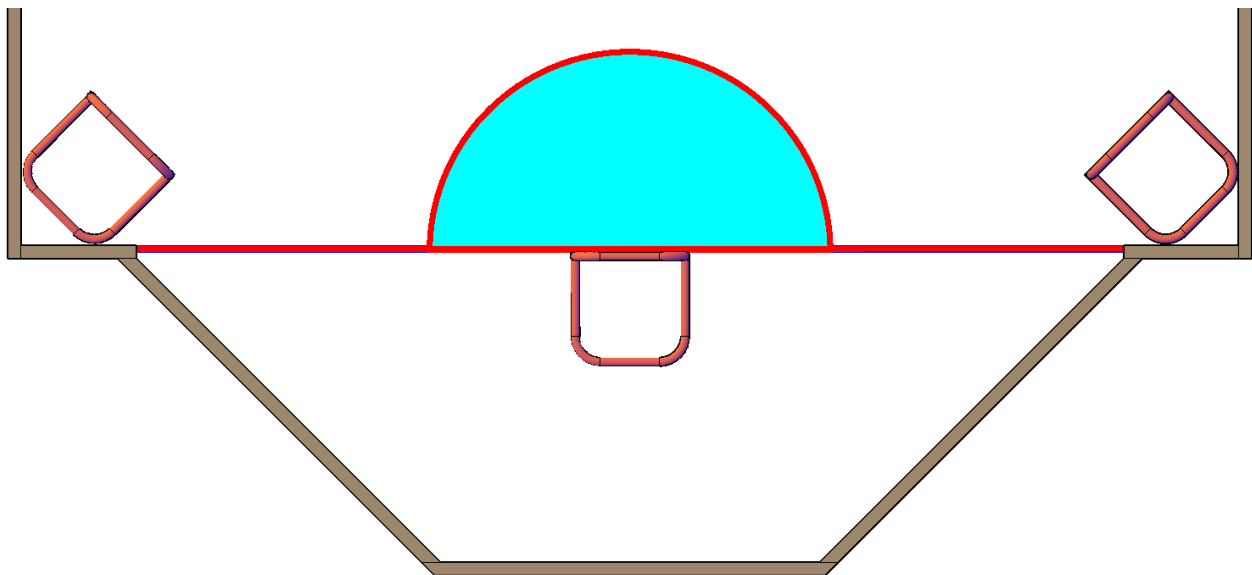

Figure 6: Net placement

- d) Each net will be equipped with a “goal line”, which will determine if a ball is considered within the net.
- a. At no point are teams allowed to remove balls from inside of the net.
 - b. A ball is considered in the net if:
 - i. It is completely within the net. This is defined as the ball being located completely within the net and not breaking the vertical plane of the inside of the goal line.
- Or
- ii. It is touching the court floor within the net.
 - iii. NOTE: If a ball is not completely within the net and not touching the court floor inside of the net, it does not count as being in the net.

3.6: Driver Zones

- a) Each competitor must remain within their driving area for the duration of the game.
 - i) Teams will be able to select which competitor occupies which driver zone.
- b) Driver zones are located in the triangular sections at the end of the court alongside their “Defensive Zone”.
- c) Driver zones will include an exterior barrier to ensure drivers remain within their appropriate areas.
 - i) Only 2 competitors per team are permitted to compete during a game.
 - ii) Teams with competitors operating in a non-driver role may allow one competitor to occupy an unoccupied driver zone.
 - iii) If any competitors are not occupying a driver zone, they are not allowed to communicate with those in the driver zone during game time, and must remain at least 5 feet from the court.

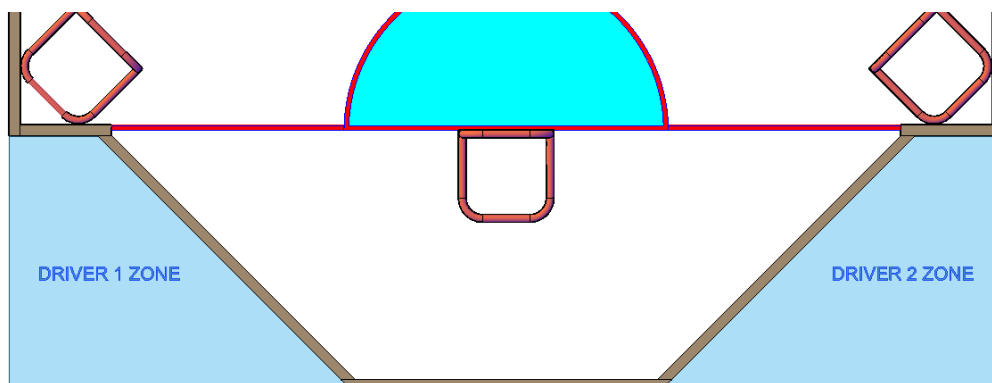

Figure 7: Driving zones

3.7: Starting Zones

- a) Tele-operated robots must start in the area behind the goal line (Defensive Zone Trapezoidal area).
 - i) All tele-operated robots must start fully within this area.
- b) Autonomous robots must start within the autonomous zone.
 - i) Autonomous robots must start within the "Autonomous Zone".
 - ii) Autonomous robots will be allowed to turn on prior to the beginning of the tele-operated game.
 - iii) Autonomous robots are allowed to be in motion from the time they are turned on.
 - iv) Competitors are not allowed to touch the autonomous robot at any time during the tele-op match.
 - 1) NTC/Judges reserve the right to stop the autonomous robot for the purpose of safety and damage prevention.

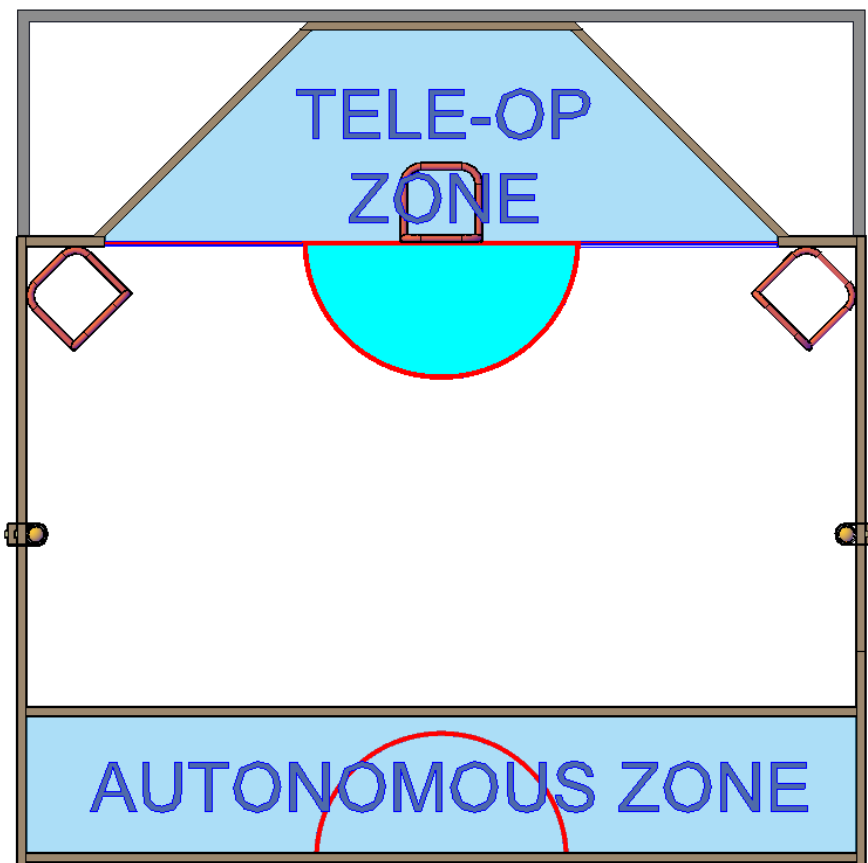

Figure 8: Starting zones

3.8: Game Pieces

a) The miniature hockey nets are as follows:

- i) The nets are “Franklin Sports Mini Skills Street Hockey Goal - Outdoor + Indoor Steel Mini Hockey Net” available [here](#), or a hand-made equivalent with identical dimensions.



- ii) Each net will be equipped with a “goal line”. This “goal line” will determine if a ball is considered in the net.
 - 1) The goal line will be a 1 inch wide strip of 4mm corrugated plastic, extending across the opening of the net (from the bottom of each post).

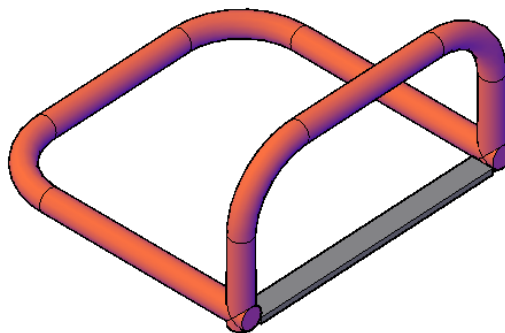

Figure 9: Standard Net with Corrugated Plastic

b) The hockey balls are as follows:

- i) “Franklin Sports NHL Street Hockey Balls - No Bounce Outdoor Street + Roller Hockey Balls - Official Size” available [here](#).
- ii) They are officially sized at 2 $\frac{5}{8}$ inches in diameter.

c) The hockey balls will start in the ball dispensers located on the exterior wall in the Defensive area.

- i) Each dispenser will contain 10 hockey balls at the start of the game. This means teams will start with 20 total hockey balls on their side of the court.

d) Hockey balls are not to be intentionally removed from the court, or directed over a barrier.

- i) Doing so could result in disqualification from the game.
- ii) This includes shooting a ball over the middle barriers, or purposefully removing

them from the court.

3.9: Shooting Mechanisms

- a) Robots must use the following hockey blade for their shooting mechanism:
 - i) Plastic road/street hockey blade with the maximum blade dimensions:
 - 1) The blade shall not exceed 12 ½ inches in blade surface length, 3 inches in height, and ¾ inches in thickness.

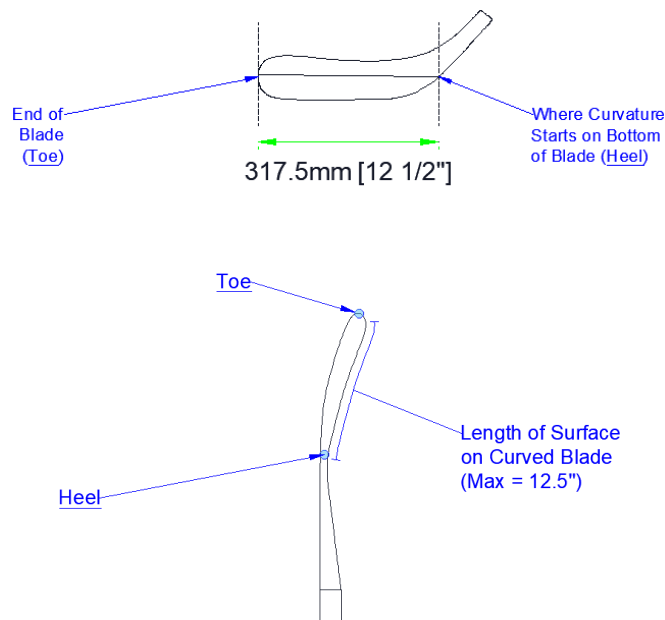

Figure 10: Curve Length Measuring Points

- b) The hockey blade is the only surface from which a ball is allowed to be purposefully shot.
 - i) The shooting mechanism **must use the blade of the “stick” to shoot the ball.**
 - ii) Pushing or shooting the ball intentionally with other parts of the robot are not permitted.
 - iii) Balls bouncing off a robot will be allowed, as long as they are legal.
 - iv) This includes any autonomous robot in use for the main game.
- c) Allowable modifications to the blade:
 - i) Curving the blade is permitted.
 - ii) Blades may be cut down to smaller size.
 - iii) Blades are not permitted to be extended beyond the original blade size.
 - iv) Blades are not permitted to have protrusions out of the “blade surface”.
- d) A maximum of one blade is permitted per robot (autonomous included).
 - i) The hockey blade itself is not counted toward the overall volume of the robot, but

the mounting hardware is counted toward the overall volume.

3.10: Additional Notes

- a) At no time is a robot permitted to intentionally remove a hockey ball from play.
 - i) Teams are not to intentionally put a ball out of the court space.
 - ii) Doing so could result in disqualification.
- b) At no point is a team permitted to break the vertical plane of the shared middle wall.
- c) At no point is any robot permitted to intentionally reach over the exterior walls or zone barriers.
- d) At no point is a team permitted to shoot a hockey ball over the barriers.
 - i) This will be treated as the same as intentionally removing a ball from the court.
- e) At no point is a team permitted to purposely drop pieces off of their robot.
- f) At no point in time are robots permitted to be on top of any net. This is defined as:
 - i) Touching the top of the net in any form will be considered being on top of the net.
 - ii) The top of the net is bound by the external vertical plane of all sides of the net.
- g) At no point in time are robots permitted to be inside of any net. This is defined as:
 - i) Breaking the vertical plane of the exterior edge of the front of the net.

4. Each Team's Exclusive Use Area is approximately 12 ft. by 12 ft.

- a. Team members (max 2) must remain in the assigned driver area throughout the game.
- b. Additional team members are not allowed to communicate with the drivers or be within 5 feet of the court area.
- c. It is a Team Responsibility to define the tasks assigned to each competitor.
- d. If a Team has a Two Robot Entry, then:
 - i. Both competitors can be Robot Drivers
 - ii. Both competitors can also be Spotters for their partner driver
- e. If a Team has a One Robot Entry, then:
 - i. One competitor can be the Robot Driver and One competitor can be a Spotter for their partner driver

5. Each Team's Area includes:

5.1: Starting Area

- Robots must start in their designated starting areas. They must not break the vertical plane as defined by their barriers.
- Tele-operated robots will start in their Defensive Zone Trapezoidal area (behind the goal line). The goal line will be the barrier forming the vertical plane.
- Autonomous robots will start in their Neutral Zone, within the "Center ice" circle.

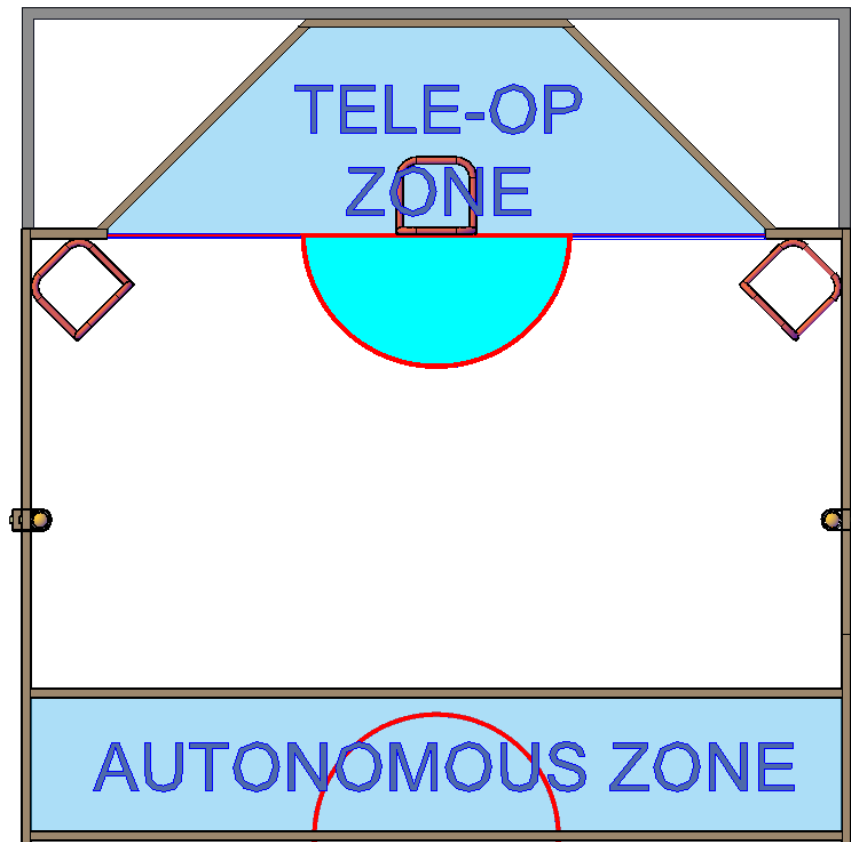

Figure 11: Starting areas

5.2: Tele-op Area

- a) Tele-operated robots will have free use of their entire Defensive Zone.
- b) Within this area are 3 nets, and 2 ball dispensers.
- c) Tele-operated robots must remain in this area at all times during the game.

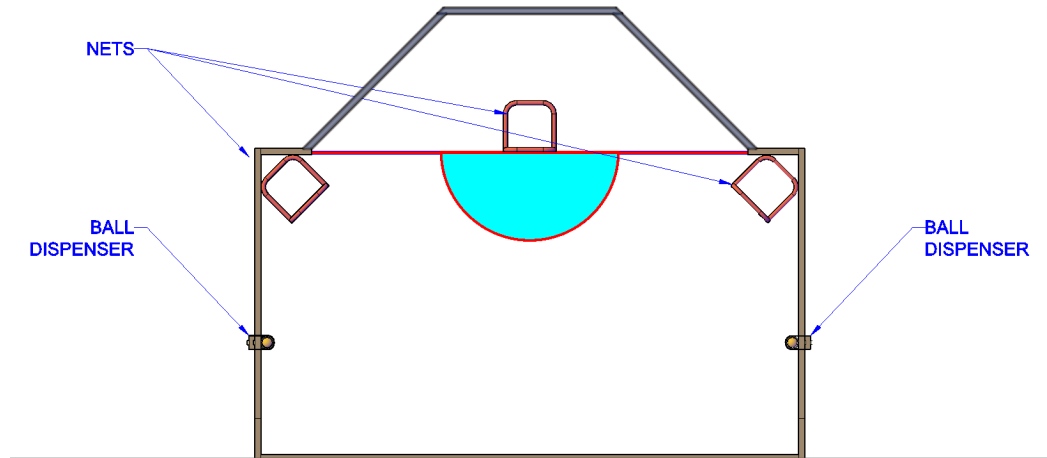

Figure 12: Tele-op area

5.3: Autonomous Area

- a) Autonomous robots will be able to use their team's entire Neutral Zone.
- b) Autonomous robots must remain in this area at all times during the game.

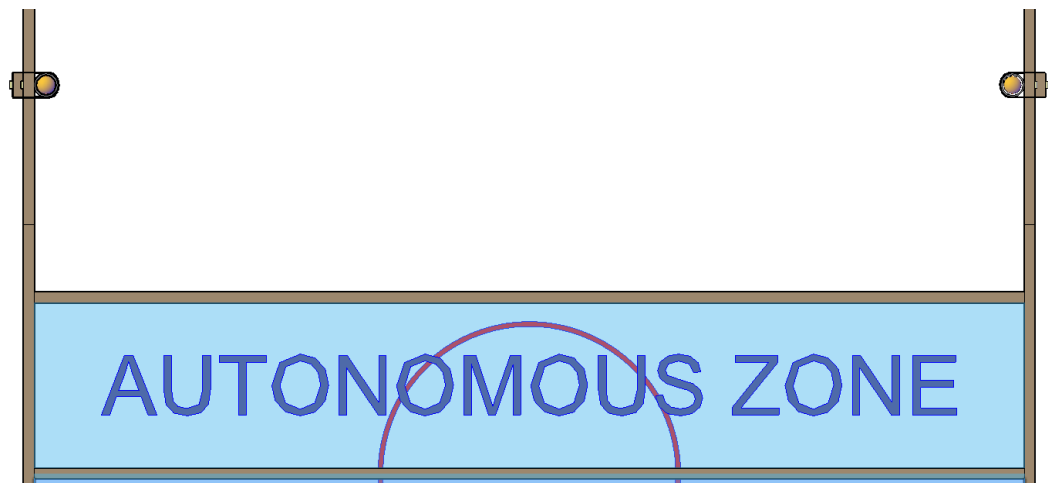

Figure 13: Autonomous area

6. Hockey Game Description

- a. Games will involve Two Teams at a time.
- b. Both Competitors are to remain in the assigned driver area.
- c. Teams can utilize a Maximum of TWO Tele-operated Robots.
- d. Teams may also use ONE Independent Autonomous Element as part of their entry (which must fit into the overall size limitation at the beginning of the game).
 - This autonomous element may be turned on prior to the match beginning.
- e. Teams may not use any other Independent Elements as part of their entry.
- f. Robots may NOT be in possession of any Hockey balls at the Start of a game.

7. Scoring Summary

Scoring will be done at the end of each 4- minute match:

7.1: Opponent Zone Balls

- a) Teams will earn 1 (one) point for every ball in their opponents Defensive Zone at the end of the 4-minute match.
 - b) Teams will earn 2 (two) additional points for every ball scored into their opponent's nets.
 - i) A ball is considered in the net if:
 - 1) It is completely within the net. This is defined as not breaking the vertical plane created by the inside edge of the goal line.
- Or
- 2) It is touching the court floor within the net.
 - c) Scoring will take place based on where the balls are at the end of the 4-minute match.

7.2: Neutral Zone Balls

- a) Balls in the Neutral zone at the end of the match are worth zero points.
- b) Balls in the Neutral zone will come into play in the event of a "tie" score after counting the "Opponent Zone Balls".

7.3: Tie-breaker

- a) All games will have a winner. There will be no ties for any games.
- b) In the event of an equal score based on the "Opponent Zone Balls" and "Opponent Net

Balls”, the following tie-breaker(s) will take place:

- i) Balls will be counted in both teams’ Neutral Zone. The team with the least balls in their own Neutral Zone will be declared the winner.
- ii) Should the teams still be in a tie, a “Shootout” will occur. Each team will take one single shot from their own crease area. The highest scoring ball determines the winner.
 - 1) Should the teams both score an equal value on their first shot, they will take another shot, cycling their tele-op robots. This continues until a winner is determined.
 - 2) Only the shooting tele-op robot will be permitted on the court during this time.

7.4: Match Record and Point Standings

- a) Teams will be ranked based on their overall game record.
 - i) Wins will be awarded 2 points.
 - ii) Tie-breaker losses will be awarded 1 point.
 - iii) Regulation losses will be awarded 0 points.
- b) The Round-Robin rankings will be used to rank teams in order, and then placed into a seeded double knockout format playoffs.
 - i) Should teams have equal points after the round robin, the following tie-breakers will be used, in order:
 - 1) Overall wins.
 - 2) Record against other tied teams.
 - 3) Tie-breaking Shootout

8. Marking Sheet

A scoresheet similar to the following will be used to record each game's score.

2023 Skills Canada - Mobile Robotics				
Hockey Game Scoresheet				
Game Number:	Team A:		Team B:	
	Count	Score	Count	Score
Balls in opponents court (1 pt each):				
Balls in opponents nets (2 pts each):				
Total Score:				
Tie-breaker (if needed)				
Balls in opponents Neutral Zone				
Shootout (if needed)				
Shot 1:				
Shot 2:				
Shot 3:				
Shot 4:				
Shot 5:				
Winner:				
Tie-breaker loss?				

9. Pit Area and Court Access

- a. A pit area is provided so that students may make repairs and improvements to their robots between games. (Note: Teachers are permitted in the pit area once the competition has started).
- b. Teams MUST bring their Robots into the skill area at Orientation.
- c. The pit area and contest court may be available to teams to work or practice during lunch breaks if a Robotics Committee member is present.

10. Game Play

- a. Teams will participate in a 'Round Robin Tournament' leading to a 'Seeded Double Elimination Playoff Tournament'.
- b. Hockey Game Tournament Standing will be based on the total number wins in all games played by each team.
- c. Teams will play a balanced number of Tournament Games.
- d. Teams will participate in an equal number of Games in the Round Robin Tournament.
- e. There will be Hockey Playoff Games.
- f. Tournament games will last 4 minutes.
- g. The tie-breaker procedure for all games will follow the method described above in the scoring section. There will be no tie games.
- h. The amount of time between games will be determined by the number of participants. This information will be provided to teams at the start of the tournament.
- i. Between tournament games, battery changes and repairs to robots may be completed at the team's assigned Pit Area Worktable.
- j. During the competition, protective safety glasses are expected to be worn while performing material removal tasks (cutting, drilling, etc.).
- k. During game play, referees will have ultimate authority over game rulings, and will have full authority over team conduct in the court area.
- l. No aerial (flying) robots are allowed.
- m. Damaging the court area is prohibited. If a robot's design causes damage to the court elements*, then it will not be allowed to compete until it can operate without causing damage. Games missed due to this situation will be forfeited.
NOTE: Damage involves BREAKING court components. Robots bumping into court

components and causing them to shift position without breaking any court element will NOT be viewed as damaging the court. It is expected that all court components will be fixed firmly in place so that the court is a Neutral Factor in the competition.

- n. Games will start on time. Teams are responsible to know when their games are scheduled. Teams arriving late will be allowed to use the remainder of the time in the game. Competitors cannot enter onto the court surface or adjust their robot during a game.
- o. If a robot is mal-functioning and represents a hazard to participants, other robots or itself in the opinion of the Referee, then, the referee may stop the clock, and may authorize the shutting off the robot during a game. Disabled robots or parts of robots not generating any safety concerns will be left on the court until the game time expires.
- p. It is a Team Decision what roles team members will fill. Drivers are the competitors holding the robot controller(s) and asserting direct control over a Tele-operated robot.
- q. The Spotter would be the competitor providing navigational guidance to the driver.
- r. Competitors may change roles while a game is in progress.
- s. Competitors (Driver/s and/or Spotters) must remain in their assigned area throughout the game.
- t. Competitors may not enter an opponent team's Assigned Courtside Team Area at any time during game play.
- u. At the start of a game, robots are expected to be in their Designated Starting Position.
- v. Robots arriving AFTER a game has started will be allowed to enter the game and use the Time remaining in the 4 min. game.
- w. Robots must not leave the contest court at any time during a game.
- x. It will be a referee's ruling that decides if an 'End of the Game Component Placement' took place before or after the game-ending buzzer sounded.
- y. If a Hockey ball falls out of the court, it may not be retrieved and will be considered out of the game for the remainder of the game time.
- z. Scoring will take place after the End of the Game Buzzer.

11. Court Layout

- a. Please note: Although great pains will be made to keep the court in compliance with the drawings, some inaccuracies in construction may occur. **Please make your robot designs allowing for a possible ½ inch tolerance.**
 - i. The open court surface will consist of the good side of Plywood Sheets **OR** the facility floor **OR** the smooth side of Masonite Sheeting.
 - ii. Detailed court information has been included in the Appendix Section of this document.

12. The Robot(s) Restrictions

- a. All tele-operated Robots must pass a pre-competition inspection for compliance with the safety and design rules before they will be allowed to participate in tournament games.
- b. **Note:** Robots must remain in compliance with these rules throughout the competition. If teams fall out of compliance with these rules, then they will not be permitted to compete and will forfeit all their scheduled games until they have corrected the problem.

13. Start of the Game Robot Status

- a. When a robot's main power is turned on prior to the start of a game the robot must be in an overall 'Idle State' and the following conditions must exist:
 - i. Robots must be stationary.
- b. Robots must be in their designated Starting Location.
- c. If Team Entries involve multiple Robots / Mechanisms, then all of them must fit within their starting locations and must be positioned to not exceed the allowed total 4 cubic feet volume per Team, as described in Section 14.
- d. All systems may be ON.
- e. Air System Circuits may be fully charged to a maximum of 100 PSI and their compressors can be ON.

14. Overall Team Robot Entry Size

- a. Complete Team Entries must fit within the designated starting area at the start of each game, as defined by the vertical plane of the starting area.
- b. Complete Team Entries must not exceed an overall size of 4 cubic feet (6912 cubic inches) at the start of each game.
- c. Team Entries may expand to a larger size once a game has started.
- d. Team Entries may start in 2 parts:
 - i. Tele-op robots must start together, and their total volume will be taken based on their overall starting position.
 - ii. Autonomous robots must start in the autonomous starting zone. Their volume will be taken based on their starting position (defined as the starting position at the beginning of the tele-op match).
 - iii. Total volume will be calculated by adding the total tele-op volume to the total autonomous volume, like this:

Total Tele-op Volume + Total Autonomous Volume = Total Volume.

15. Power Sources / Management

- a. The total voltage in any individual circuit cannot exceed 24 Volts.
- b. The maximum continuous power rating allowed in any circuit branch is 240 W, which will be limited by voltage and fuse selection. A larger main fuse can be used to provide protection for motor controllers. To calculate power in any given circuit, use the following formula: Power (Watts) = Voltage (Volts) x Current (Amps)

Acceptable Circuit Protection: (ESC is NOT protected by fuse)

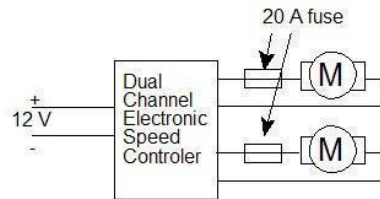

Recommended Circuit Protection: (ESC IS protected by fuse)

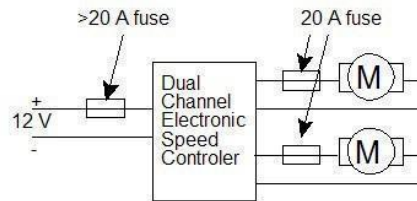

Figure 14: Circuit Protection

- c. Teams are reminded that it is the purpose of a fuse to protect the students themselves and the equipment in their circuits. Teams must develop circuit diagrams and calculate the appropriate values for all circuits on their robot. **Teams must submit a wiring diagram of their robot's circuits.**
- d. Each current branch path from the battery must include either an in-line fuse, resettable fuse, circuit breaker, or be connected to a dedicated fuse in a rack.
 - i. Devices with a known, dedicated internal fuse (based on manufacturer's documentation) are considered to have this requirement met, assuming the fuse rating is appropriate.
- e. Batteries must be complete sealed commercial battery packs.
- f. ALL Robots must be able to be turned off with a single motion.
- g. Robot Controller receivers may be in an independent circuit.
- h. No explosive materials of any kind may be used (ether, gunpowder, acetylene etc.)

16. Non-Electrical (Battery) Energy Sources

- a. Pressure based energy sources (air or other) may be pre-charged to a maximum of 100-PSI pressure in their reservoirs (cylinders) at the start of each game.
- b. Air pressure systems using Competitor-made or modified air pressure hardware are NOT permitted.

- c. All pressurized tanks on robots must have a pressure gauge to indicate the stored pressure and a form of automatic overpressure safety relief system.
- d. The pressure tanks and related gauges / controls must be shielded from damage due to collisions or flying target objects.
- e. The stored pressure in the tank must not exceed a maximum of 100 PSI at any time.
- f. Tension-based energy sources (elastics, springs or other) may be in either a relaxed at rest state or in a tense / compressed state at the start of each game.
- g. Laser devices are prohibited.
- h. Hydraulic fluid systems are not permitted.

17. Recommended Robot Controllers

- a. It is recommended (not required) that all teams use 2.4 GHz “non-crystal” control systems on Tele-operated Robots.
- b. Teams are allowed the use of an unlimited number of channels, but only two separate tele-operated robots. Teams assume full responsibility if any interference is to occur with their respective communication systems that could render the robot(s) useless.
- c. Tele-operated Robots may not transmit audio/visual information to off the robot devices. (Ex: Having a camera transmit images real time to a computer near the driver, etc.)

18. Pit Area

- a. Competitors **MUST** wear safety glasses when doing fabrication work involving material removal processes (grinding / cutting).
- b. Only registered competitors and teacher sponsors are permitted in the contest space.
- c. Teacher sponsors are not permitted to handle tools or robot parts, but may only provide advice to competitors. Students must affect all repairs and modifications on their robot.
- d. Teams will be provided with a pit area workspace on a standard project table. Depending on the number of teams and availability of space, teams may have to share a 60 by 30-inch table.

- e. **It is required that teams fabricate a tabletop stand for holding their robot(s) in the pit area.** This stand or these stands should hold the robot(s) securely and be capable of preventing the robot(s) from driving on or off the table in the case of either deliberate motor testing during repairs or due to random, unexpected motor activity.

19. Overall Court Description:

- a. The Court Playing Surface will be a 12' by 24' area.
- b. Individual Exclusive Use Team Spaces are approximately 12' by 12' areas.
- c. The Perimeter Court Walls will be made using 2 by 4-inch planks.
- d. This wall will as a result be approximately 3.5 inches tall.
- e. The court surface may vary between melamine, concrete, hardboard, or plywood.

20. Pre-inspection for Compliance with Safety and Design Rules

- Mandatory Wiring Diagram provided.
- Tabletop Robot Stand
- Overall volume $\leq 4 \text{ ft}^3$ or 6912 in^3
- Hockey Blades meet restrictions
- No explosives/combustibles
- No lasers
- All batteries are sealed commercial batteries in good physical condition
- Batteries wired in series should be the same amp hour rating (ex. both 1500 mAh) and batteries in parallel are of same voltage (ex. both 12 volts).
- Batteries securely mounted
- Total voltage in any individual circuit does not exceed 24V
- No circuit **branch** exceeds 240W (Voltage x Fuse Current Rating, easily accessible)
- All circuits have a fuse or breaker (breakers must have **DC rating**) and all Fuses / Breakers must be readily accessible.
- Mandatory Pressure System Circuit Diagram provided.
- No Competitor-made or modified air pressure hardware being used.
- Only commercially manufactured Pressure Tanks (cylinders) can be used.
- Pressure indicator
- Pressure in tanks does not exceed 100 psi
- Over-pressure safety valve
- Pressure tanks and related gauges and controls are shielded from damage due to collisions
- Robot can be turned off with a single motion.** Radio receivers / Logic circuits may be independent of the kill switch. This includes all tele-op and autonomous robots.
- Control unit to support operator to robot communication are being used.
- Demonstration of robot functionality

Additional concerns:

--	--

Robot Evaluator Signature

Team Representative Signature

21. Autonomous Competition Overview:

IMPORTANT NOTE: The information in this section does NOT pertain to the NL Provincial Skills Competition. The information is provided to give insight into the Autonomous component of the National Skills Competition.

- a. Competitors will be provided, at no cost to the teams, with a kit distributed to them through their provincial/Territorial office.
- b. The autonomous robots must be disassembled on arrival.
- c. A description of the Competition Component Collection will be posted on the Skills/Compétences Canada Website.
- d. Competitors will demonstrate their robot's performance in a court to be defined at the Skill area.
- e. At the orientation meeting, Competitors will be told the specific Robot Behaviors their Built On-Site Robots need to complete.
- f. The suggested performance items listed below reflect the type of core isolated robot performance elements competitor robots will need to complete
 - i. Follow wall perimeter,
 - ii. Navigate a maze,
 - iii. Navigate around obstacles,
 - iv. Follow a colored tape line on the floor,
 - v. Locate and touch an object
 - vi. Pick up a small object and move it to a new location
- g. Competitors MUST understand the list above represents Samples ONLY and does not present a final or complete list of the potential robot behaviors they might be asked to create.
- h. Teams need to develop an understanding of the performance capabilities of ALL components in the Competition Collection and prepare to be able to use any of these components effectively.
- i. Competitors need to be prepared to go beyond the initial single stage performance requirements to multi-stage performance requirements as the culminating end of the competition experience.
- j. Build On-Site Autonomous Tasks Equipment: Competitors will be required to build their autonomous robot solutions using ONLY the contents of the provided to all teams 2021 Skills Canada Component Collection. If a Robot Component is not provided in the common to all 'Box of Component's' then it cannot be installed on the Competitor's Autonomous Robot.
- k. Teams will have time periods where they have shared access to the various Autonomous Performance Court Environments to conduct their Task Solution /

Preparation Activities

- l. Teams will have a select number of Marked Attempts at each of the Autonomous Performance Tasks as time permits. The number of attempts will be predetermined at the start of the competition.
- m. Marked Autonomous Task Attempts will be conducted on a 'By the request of the Teams Basis with a requirement that Teams complete ALL Autonomous Task Preparation Activities by an announced at the start of the competition Fixed Time:
Example: All Autonomous Task Preparation Activities must end by 3:45 PM on Competition Day 2.
- n. Team Marks will be based on their Best Performance out of their attempts.

21.1 Exception List to "Only what is in the box"

- a. Laptop/Computer, mouse, and keyboard, power cord, usb cable, software drivers
- b. Sample code, Arduino IDE or similar program
- c. Measuring tape, allen keys, small wrench or pliers
- d. Paper, pen, pencil, calculator to record measurement
- e. Replacement parts for the originals ie. Cable ties
- f. Large and/or small storage containers

Appendix A: Court Area Dimensions and Details

Refer to the following document for court dimensions and details.

https://www.skillscompetencescanada.com/wp-content/uploads/2022/09/SCNC23_23S_Appendix-A-Court-Dimensions_EN.pdf

Note that the NL Provincial Robotics Competition court will be identical to the court for the National Robotics Competition, with the exception that the court perimeter will be made from 2x4 lumber, instead of 2x6 lumber.